

MS-10/MS-10S

Meeting System

User Manual - English



Version 101

To download the latest version of Quick Start Guide, multilingual user manual, software, or driver, etc., please visit Lumens <https://www.MyLumens.com/support>

Contents

Chapter 1 Package Contents	2
Chapter 2 Product Overview and Interface	3
2.1 I/O functions Introduction	3
Chapter 3 Connection and Instruction for Installation	4
3.1 How to connect	4
3.2 Instruction for installation	4
3.3 Device Size	5
3.4 Relative Operation Position	5
Chapter 4 Introduction of Remote Control and Setting Menu	6
4.1 Remote Control	6
4.2 Setting Menu	7
Chapter 5 Descriptions of Major Functions	10
5.1 Control the Camera	10
5.2 Use Skype for Video Conference	10
5.3 Save the current screen position data	10
5.4 Adjust the direction and position of the screen (ePTZ)	10
5.5 Use the Auto Frame	10
5.6 Use the Speaker Tracking (For MS-10S only)	10
Chapter 6 Output Resolution	11
Chapter 7 Troubleshooting	12
Chapter 8 Safety Instructions	13
Copyright Information	14
Supplier's Declaration of Conformity 47 CFR § 2.1077 Compliance Information	15

Chapter 1 Package Contents

MS-10/MS-10S



Remote Control



3 PIN to 2 PIN Connector



(For Japan only)

Power Cord

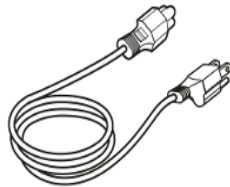

Appearance may vary depending on country/region

Power Adapter

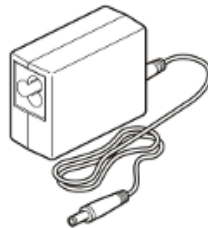

USB 3.0 Cable (Type B-Type A)



TV Mount Bracket x2



L-shaped Sheet Metal x2



TV Mount Sheet Metal x4

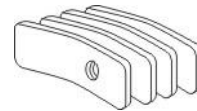

Screw (1/4"-20UNC) x8



M6 Screw x4



Chapter 2 Product Overview and Interface

2.1 I/O functions Introduction

2.1.1 Front Panel

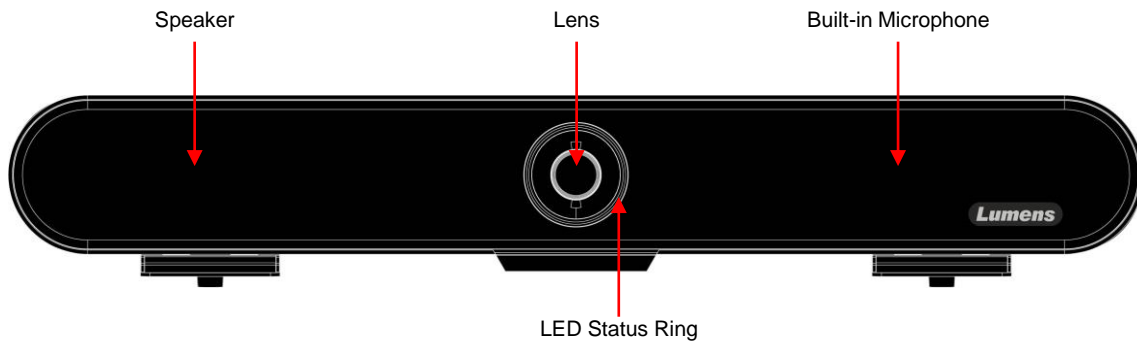

2.1.2 Rear Panel

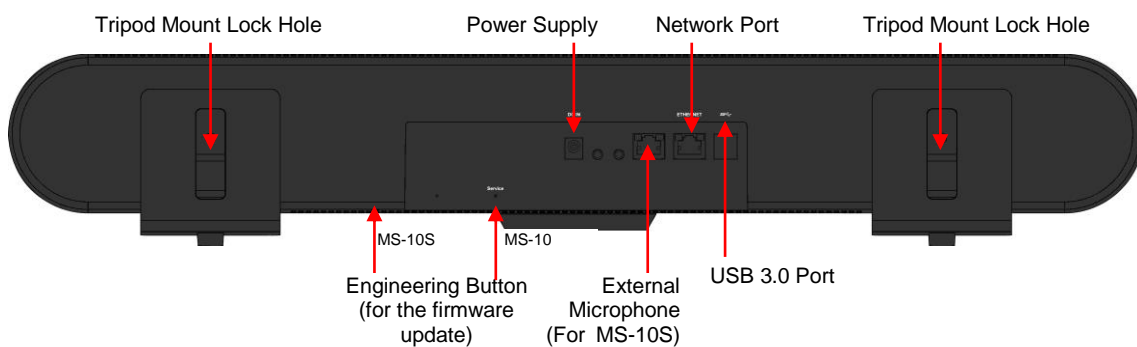

2.1.3 LED Status Ring Indicator Description

Indicator	Description
OFF	Unpowered/not connected to USB
Green	In standby mode
Red	Audio mute
Blue	In use
Green light increase/ decrease	Increase/decrease speaker volume

Chapter 3 Connection and Instruction for Installation

3.1 How to connect

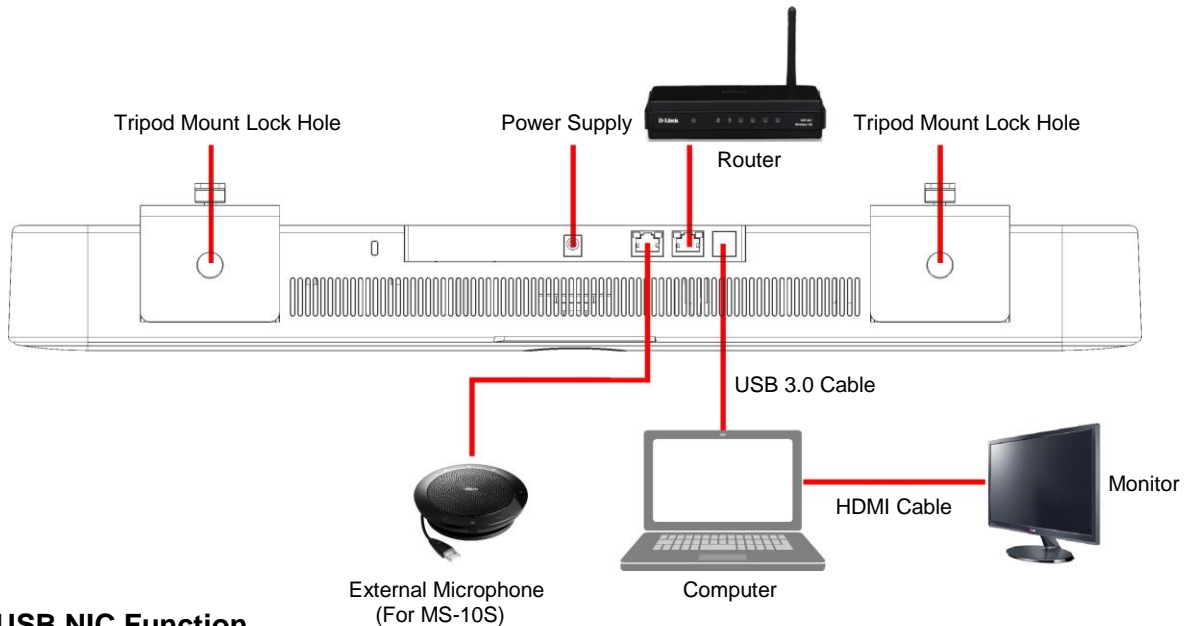

■ USB NIC Function

- MS-10/MS-10S USB 3.0 port supports network interface card function. Connecting the MS-10/MS-10S network port to the router allows you to access the Internet without connecting a network cable on the computer
- Please download the driver from Lumens website

<https://www.MyLumens.com/support>

- Supported Operating System

OS	Supported Version
Windows	Windows XP/7/8: Manual installation Windows 10: Built-in drivers
MAC OS X	10.8 or above
Linux	USB NIC Linux driver for Kernel up to 5.6

3.2 Instruction for installation

The recommended installation height is the horizontal position of the human eyes after sitting down to get the best image

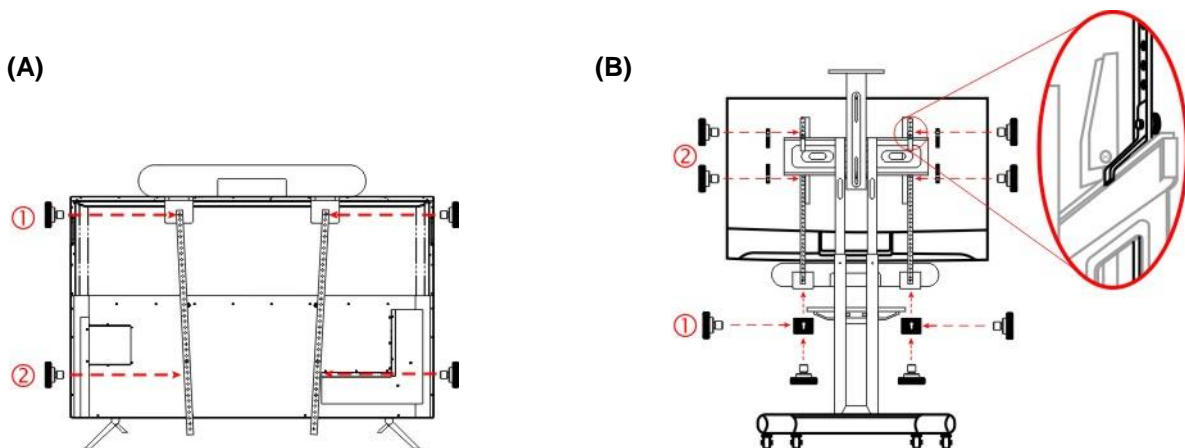

A. When the screen is placed on the platform

- ❶ Screw MS-10/MS-10S to the TV Mount brackets and place it onto the screen.

② Screw the TV Mount brackets to the back of the screen, and then tighten the screws that secure MS-10/MS-10S to the TV mount brackets.

<Remark> Please adjust the locking position of the TV Mount brackets according to hole position on the screen.

B. When the screen is mounted on the TV Mount brackets

① Fasten MS-10/MS-10S to the TV Mount brackets with screws.

② Place the TV Mount sheet metals on the top/bottom of the TV Mount brackets, and fasten the TV Mount brackets and the TV Mount sheet metals with screws from inside out.

<Remark> If MS-10/MS-10S is installed under the screen, use the L-shaped sheet metals to lock it to MS-10/MS-10S before starting the installation.

<Remark> Depending on the screw lock points of different TVs, the stainless steel bracket after installation is as shown in Figure (C) or (D)

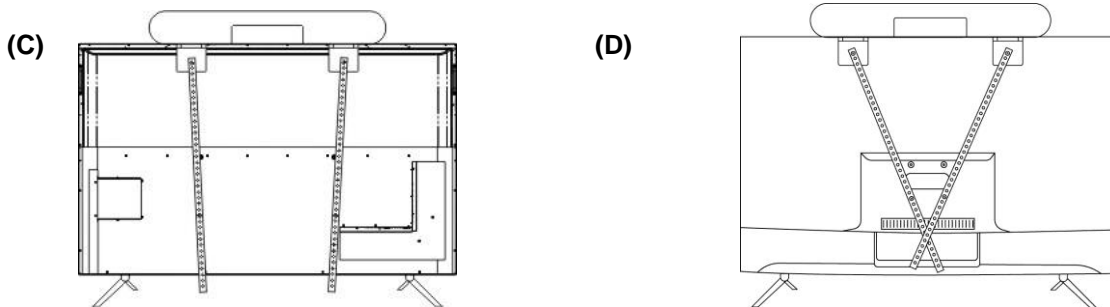

3.3 Device Size

- Length x Width x Height: 602.25mm x 73.7mm x 94.01mm
- Weight: 1.5 kg

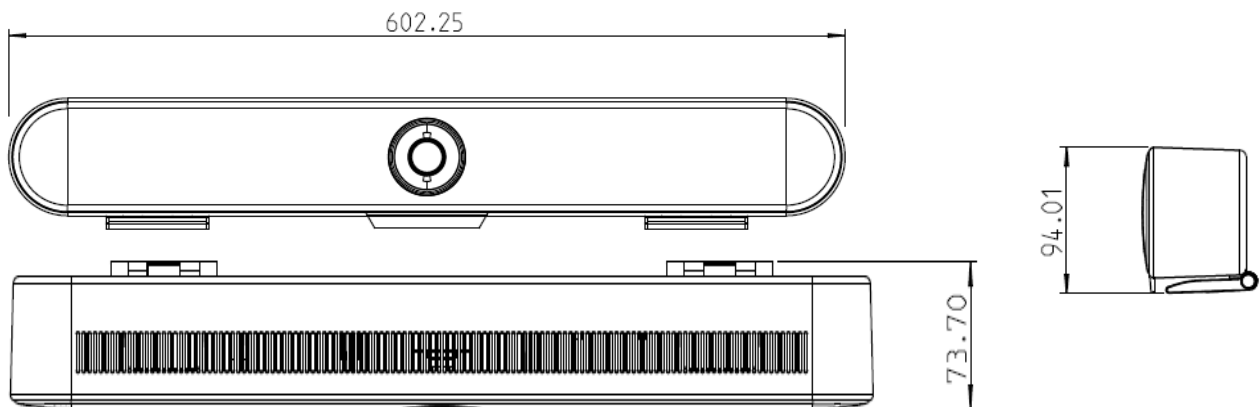





3.4 Relative Operation Position



Chapter 4 Introduction of Remote Control and Setting Menu

4.1 Remote Control

	No.	Function Descriptions
	1	Enable/Mask Images
	2	Enable/Disable Auto Frame <ul style="list-style-type: none"> Enable: Displayed in the upper right corner of the screen  Disable: Displayed in the upper right corner of the screen  <p><small>Note</small> 4K resolution does not support Auto Frame</p>
	3	 <ul style="list-style-type: none"> ePTZ: Screen moving direction Setting Menu On: Select function
	4	HOME/OK Button <ul style="list-style-type: none"> ePTZ: Back to the wide angle Setting Menu On: Confirm button
	5	Increase/decrease speaker volume <ul style="list-style-type: none"> Increase volume: Increment of green light on the LED status ring Decrease volume: Decrease of green light on the LED status ring
	6	Turn on/off the setting menu
	7	Call/Set the preset <ul style="list-style-type: none"> Short press: Call the preset 1~3 Press and hold: Save the preset 1~3
	8	Mute/Unmute <ul style="list-style-type: none"> Mute: LED status indicator shows red Unmute: LED status indicator shows blue Press and hold for 3 seconds to switch to: Enable/disable noise reduction <ul style="list-style-type: none"> Enable noise reduction: Displayed in the upper right corner of the screen  Disable noise reduction: Displayed in the upper right corner of the screen 
	9	Turn on/off Speaker Tracking <p><small>Note</small></p> <ul style="list-style-type: none"> -仅适用 MS-10S -4K 分辨率未支持声音追踪功能
	10	Zooming in/out the image

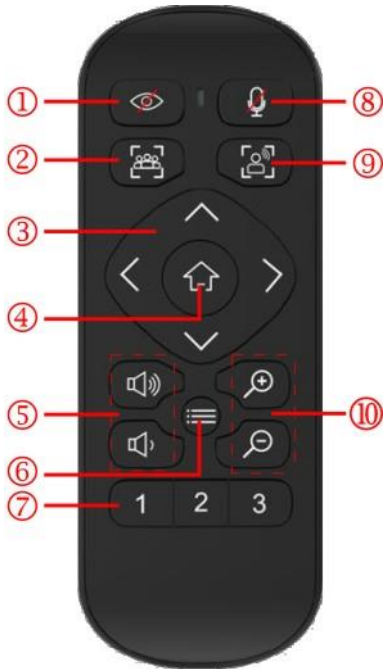

4.2 Setting Menu

▪ MS-10

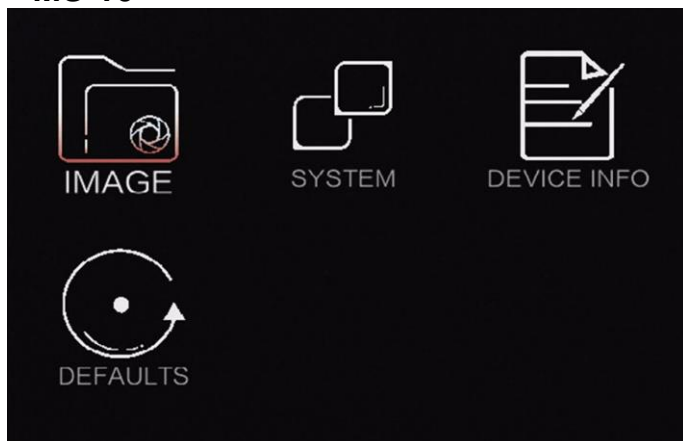

1st Level	2nd Level	Adjustment Values	Function Descriptions
Image	Auto Frame	On/ Off	The camera can automatically detect the position of the human body and adjust the person to the center of the screen according to the number of people in the meeting scene to present the best image
	Brightness	0~14	
	Contrast	0~14	
	Hue	0~14	
	Saturation	0~14	
	Sharpness	0~15	
	Gamma	0~4	
	Gain	0~14	
	Anti Flicker	50Hz/ 60Hz	
	Backlight Comp	On/ Off	
System	Language	中文/ English	
	Mirror	On/ Off	
	Flip	On/ Off	
	Expert Mode	On/ Off	The identifier frame will appear after enabling Auto Frame. It helps users to know the current detection precision and if there is any on-site tracking issue caused by environment interference
	Detection Sens.	Low/ Mid/ High	Adjust the detection sensitivity of Auto Frame
Device Info.	IR Address	1	
	Firmware Version	-	
Defaults	Defaults	Confirm	Reset to the default settings

▪ MS-10S

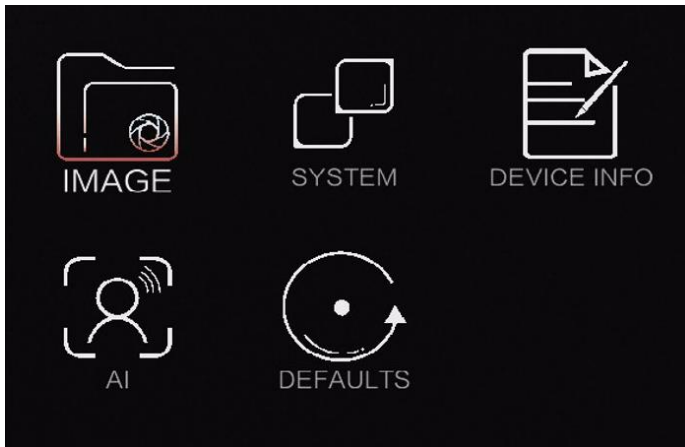

1st Level	2nd Level	Adjustment Values	Function Descriptions
Image	Brightness	0~14	
	Contrast	0~14	
	Hue	0~14	
	Saturation	0~14	
	Sharpness	0~15	
	Gamma	0~4	
	Gain	0~14	
	Anti Flicker	50Hz/ 60Hz	
	Backlight Comp	On/ Off	
System	Prompt	On/ Off	
	Language	中文/ English	
	Mirror	On/ Off	
	Flip	On/ Off	
	DZOOMLIMIT	x2/ x3/ x4	
	OSD MENU MIRROR	On/ Off	
	CODING TYPE	-	Device will reboot after the coding type changed
	H.264	Enable/ Disable	
	MJPEG	Enable/ Disable	
	NV12	Enable/ Disable	
	YUY2/	Enable/ Disable	
	AUDIO	Enable/ Disable	
	AEC	Enable/ Disable	
	ANS	Enable/ Disable	
GAIN	3~30db	ANS enabled to set the Gain value	

	EQ	Enable/ Disable	
	TREBLE	-18~12db	EQ enabled to set the db value
	BASS	-18~12db	EQ enabled to set the db value
	USB ETH. ADAPTER	On/ Off	
	MICROPHONE)	BUILT-IN/ EXT	
Device Info.	IMAGE VERSION	-	
	AUDIO VERSION	-	
AI	SPEAKER TRACKING	On/ Off	When Speaker Tracking turned On, the Auto framing function will be activated accordingly.
	AUTO FRAMING	On/ Off	The camera can automatically detect the position of the human body and adjust the person to the center of the screen according to the number of people in the meeting scene to present the best image
	EXPERT MODE	On/ Off	The identifier frame will appear after enabling Auto Framing/ Speaker Tracking . It helps users to know the current detection precision and if there is any on-site tracking issue caused by environment interference
	DETECTION SENS.	High/ Middle/ Low	
	FRAMING MOVE SENS.	High/ Middle/ Low	
	TARGET LOST ACT.	Home/ Stay/ Preset1	
	FRAMING TIME OUT	1S~6S	
	Defaults	Defaults	Confirm

Chapter 5 Descriptions of Major Functions

5.1 Control the Camera

1. Use the remote control to control MS-10/MS-10S.
2. It can be controlled using “**USB PTZ Camera Controller**” software.
Please download software from the Lumens website and [USB PTZ Camera Controller Manual](#).

5.2 Use Skype for Video Conference

Please refer to [Chapter 3 Installation and Connections](#) to finish connecting the MS-10/MS-10S and computer. Start Skype, select a contact, and press  to start the video conference.

If it doesn't work, please refer to the following steps to setup the camera:

1. Start Skype -> [Setting] -> [Audio & Video]
2. Select [**Lumens MS-10 Camera**] / [**Lumens MS-10S Camera**]
3. Select Speaker/Microphone [**Lumens MS-10 Speakphone**] / [**Lumens MS-10S Speakphone**]

After the setting is completed, the video conference is ready to begin.

<Remark> It can also be used with Zoom, Teams, Google Meet and other video software

5.3 Save the current screen position data

Press and hold the remote control number keys [1 ~ 3] to save the preset, and [**Save OK**] will display in the upper right corner of the screen.

After saving, short press the number keys to call the preset.

5.4 Adjust the direction and position of the screen (ePTZ)

1. Confirm that the screen is Zoom+
2. Press [**▲**] or [**▼**] on the **remote control** to adjust the angle upward or downward.
3. Press [**▶**] or [**◀**] on the **remote control** to adjust the angle to the right or left.

5.5 Use the Auto Frame

Press [**Auto Frame**]  on the remote control. The camera will automatically detect the locations of people, and automatically adjust the zoom to the most appropriate size to accommodate all the participants according to change of the conference venues and the number of people.

5.6 Use the Speaker Tracking (For MS-10S only)

Press [**Speaker Tracking**]  on the remote control. The camera will detect the locations of human sound, and adjust the person to the center of the screen.

Chapter 6 Output Resolution

The default output resolution of MS-10/MS-10S is 1920x1080. Please go to the connected video conference software setting to adjust the video conference output resolution.

Note Some video conference software do not have the option of adjusting the resolution, such as Skype

Format	Resolution	FPS Setting		Note
		30	25	
MJPEG	3840 x 2160	V	V	Zoom in/out is not supported.
	1920 x 1080	V	V	Default resolution
	1280 x 720	V	V	
	640 x 360	V	V	
YUV	640 x 360	V	V	Note For MS-10S only

Chapter 7 Troubleshooting

This chapter describes problems you may encounter while using MS-10/MS-10S. If you have questions, please refer to related chapters and follow all the suggested solutions. If the problem still occurred, please contact our distributors or service center.

No.	Problems	Solutions
1.	There is no image output from MS-10/MS-10S	<ol style="list-style-type: none"> 1. Replace the USB cables and make sure they are not faulty. 2. Verify whether the computer or equipment has detected the MS-10/MS-10S camera and is connected correctly.
2.	MS-10/MS-10S cannot be operated by remote control	<ol style="list-style-type: none"> 1. Try to replace the batteries of the remote control. 2. Please confirm that equipment has been connected to the computer, and launch video software. 3. Please verify the equipment LED indicator. When the signal from the remote control received by the device is normal, the LED indicator will flash.
3.	MS-10/MS-10S output resolution is low	<p>The default output resolution of MS-10/MS-10S is 1920x1080. Please go to the connected video conference software setting to adjust the video conference output resolution.</p> <p><Remark> Some video conference software do not have the option of adjusting the resolution, such as Skype.</p>
4.	↑↓↔ directional keys on the remote control cannot adjust the screen position	<p>Please make sure the screen is Zoom+.</p> <p>MS-10/MS-10S supports ePTZ. The direction can be adjusted only under the Zoom+ screen.</p>
5.	Cannot use the Auto Frame function	<p>Please check the resolution. 4K resolution does not support Auto Frame.</p>
6.	MS-10/MS-10S is not compatible with Line	<p>MS-10/MS-10S currently does not support YUY2 format, so it cannot be used with it.</p>

Chapter 8 Safety Instructions

Always follow these safety instructions when setting up and using the MS-10/MS-10S Meeting System:

1 Operation

- 1.1 Please use the product in the recommended operating environment, away from water or source of heat.
- 1.2 Do not place the product on a tilted or unstable trolley, stand or table.
- 1.3 Please clean the dust on the power plug prior to usage. Do not insert the product's power plug into a multiplug to prevent sparks or a fire.
- 1.4 Do not block the slots and openings in the case of the product. They provide ventilation and prevent the product from overheating.
- 1.5 Do not open or remove covers, otherwise it may expose you to dangerous voltages and other hazards. Refer all servicing to licensed service personnel.
- 1.6 Unplug the product from the wall outlet and refer servicing to licensed service personnel when the following situations happen:
 - If the USB port becomes damaged or frayed.
 - If liquid is spilled into the product or the product has been exposed to rain or water.

2 Installation

- 2.1 For security considerations, please make sure the standard hanging rack you bought is in line with UL or CE safety approbations and installed by technician personnel approved by agents.

3 Storage

- 3.1 Do not place the product where the cord can be stepped on as this may result in fraying or damage to the lead or the plug.
- 3.2 Unplug this product during thunderstorms or if it is not going to be used for an extended period.
- 3.3 Do not place this product or accessories on top of vibrating equipment or heated objects.



4 Cleaning

- 4.1 Disconnect all the cables prior to cleaning and wipe the surface with a dry cloth. Do not use alcohol or volatile solvents for cleaning.

5 Batteries (for products or accessories with batteries)

- 5.1 When replacing batteries, please only use similar or the same type of batteries.
- 5.2 When disposing of batteries or products, please adhere to the relevant instructions in your country or region for disposing of batteries or products.

■ Precautions

	This symbol indicates that this equipment may contain dangerous voltage which could cause electric shock. Do not remove the cover (or back). No user-serviceable parts inside. Refer servicing to licensed service personnel.		This symbol indicates that there are important operating and maintenance instructions in this User Manual with this unit.
---	---	--	---

■ FCC Warning

This equipment has been tested and found to comply with the limits for a Class A digital device, pursuant to part 15 of the FCC Rules. These limits are designed to provide reasonable protection against harmful interference when the equipment is operated in a commercial environment.

Notice :

The changes or modifications not expressly approved by the party responsible for compliance could void the user's authority to operate the equipment.

This equipment has been tested and found to comply with the limits for a Class A digital device, pursuant to part 15 of the FCC Rules. These limits are designed to provide reasonable protection against harmful interference when the equipment is operated in a commercial environment.

■ IC Warning

This digital apparatus does not exceed the Class A limits for radio noise emissions from digital apparatus as set out in the interference-causing equipment standard entitled "Digital Apparatus," ICES-003 of Industry Canada.

Cet appareil numérique respecte les limites de bruits radioélectriques applicables aux appareils numériques de Classe A prescrites dans la norme sur le matériel brouilleur: "Appareils Numériques," NMB-003 édictée par l'Industrie.

■ EN55032 CE Warning

Warning: Operation of this equipment in a residential environment could cause radio interference.

Copyright Information

Copyrights © Lumens Digital Optics Inc. All rights reserved.

Lumens is a trademark that is currently being registered by Lumens Digital Optics Inc.

Copying, reproducing or transmitting this file is not allowed if a license is not provided by Lumens Digital Optics Inc. unless copying this file is for the purpose of backup after purchasing this product.

In order to keep improving the product, the information in this file is subject to change without prior notice.

To fully explain or describe how this product should be used, this manual may refer to names of other products or companies without any intention of infringement.

Disclaimer of warranties: Lumens Digital Optics Inc. is neither responsible for any possible technological, editorial errors or omissions, nor responsible for any incidental or related damages arising from providing this file, using, or operating this product.

Supplier's Declaration of Conformity

47 CFR § 2.1077 Compliance Information

Manufacturer : Lumens Digital Optics Inc.

Product Name : MS-10/MS-10S

Model Number : Meeting System

Responsible Party – U.S. Contact Information

Supplier : Lumens Integration, Inc.

4116 Clipper Court, Fremont, CA 94538, United States

e-mail : support@mylumens.com

FCC Compliance Statement

This device complies with Part 15 of the FCC Rules. Operation is subject to the following two conditions : (1) This device may not cause harmful interference, and (2) this device must accept any interference received, including interference that may cause undesired operation.